

Article number: 021816025229

Description: Clamp with bracket and rubber  
SPGU 6025. 229/30 SK

## Measures

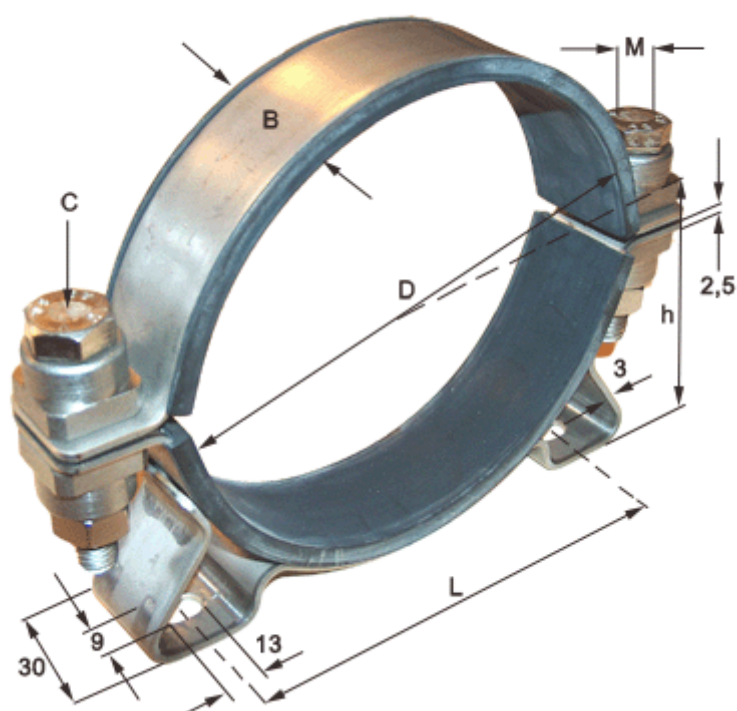

C (screw type) = SK hexagon screw

Diameter D = 229

h = 122

L = 216

Width B = 30